

U18MS

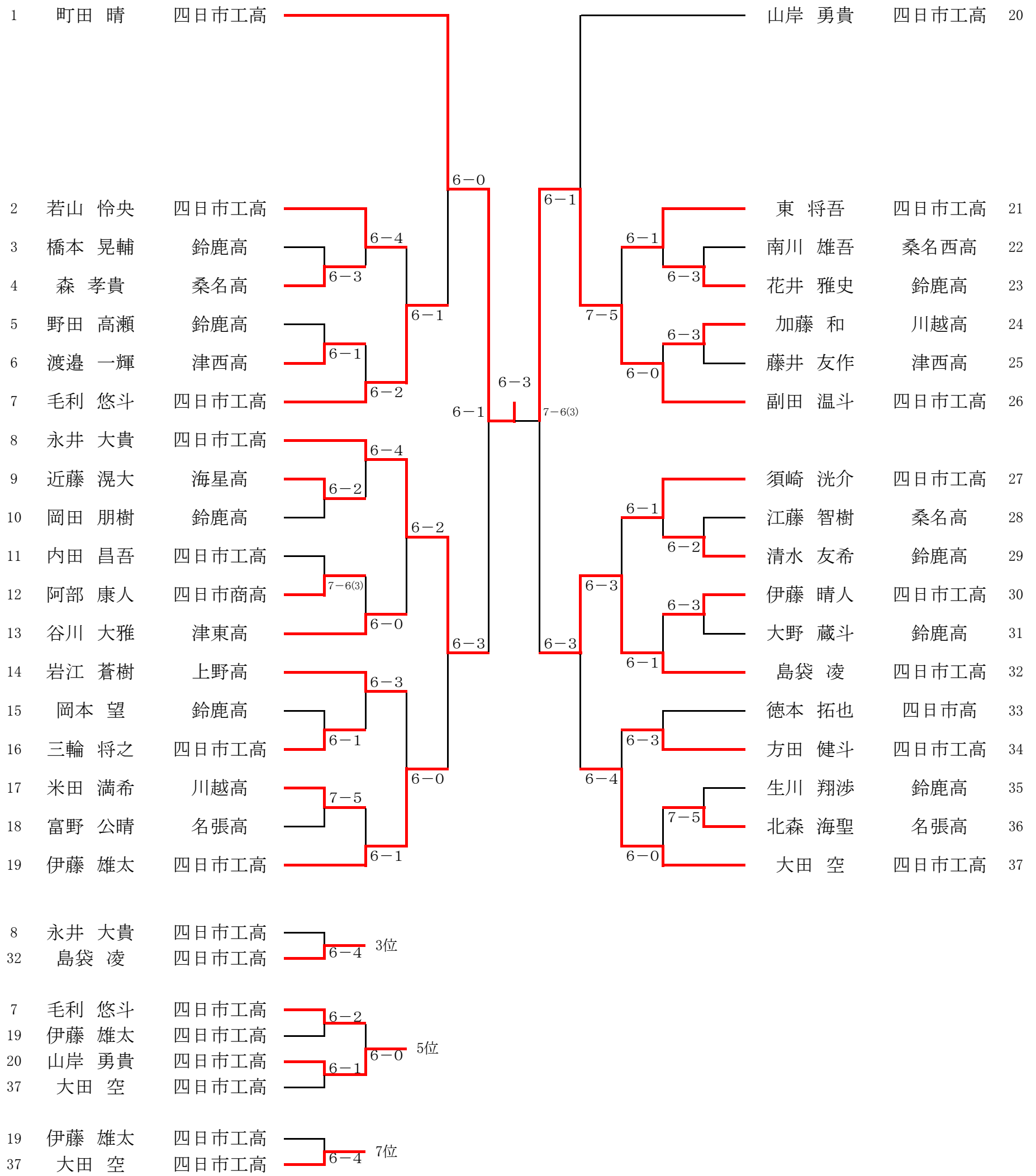

U18MD

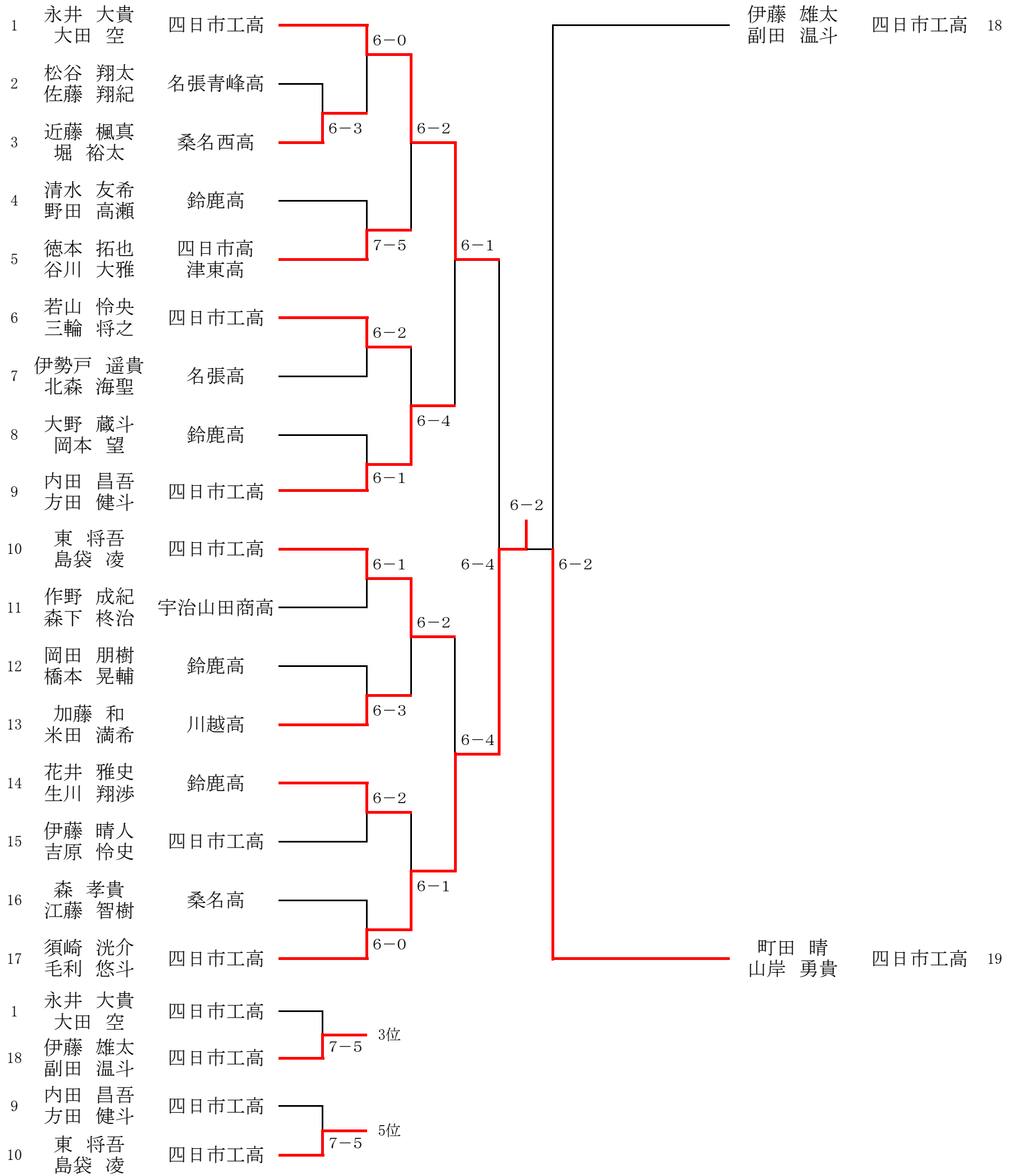

U16MS

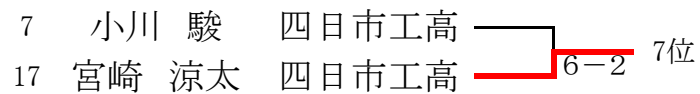
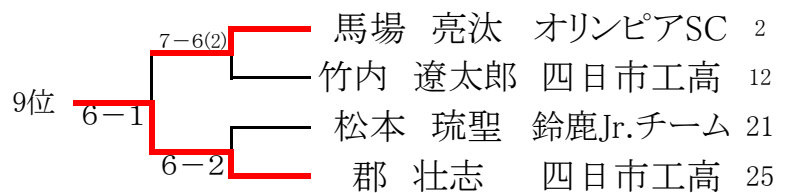
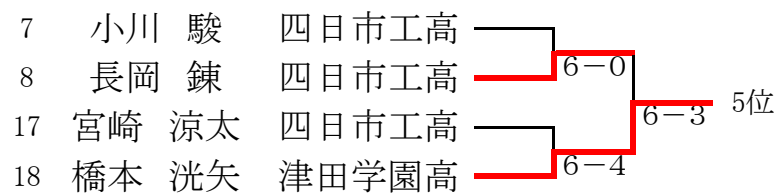
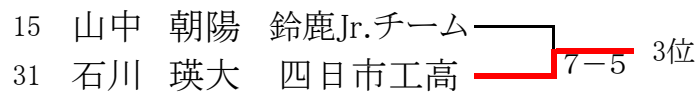
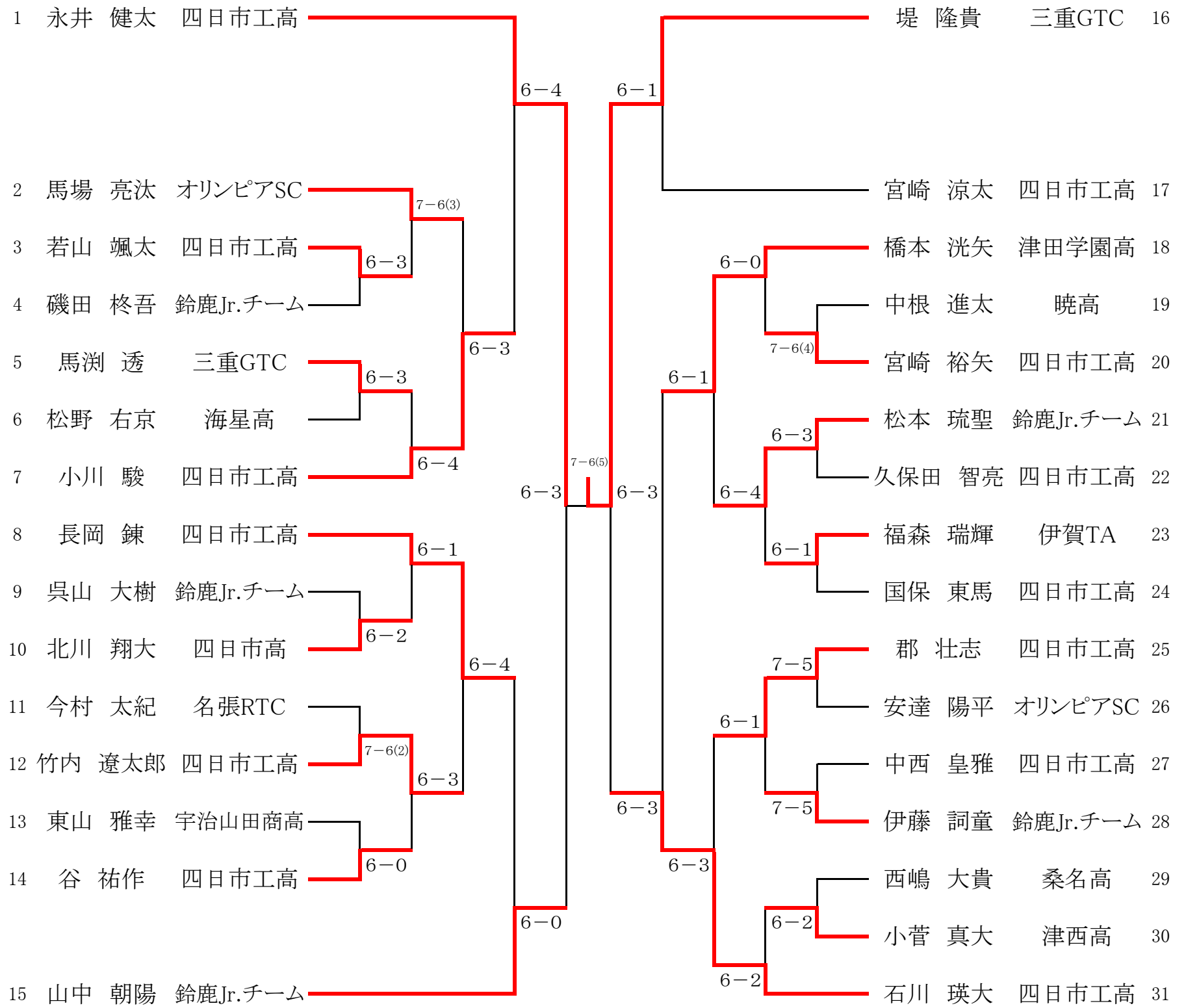

U16MD

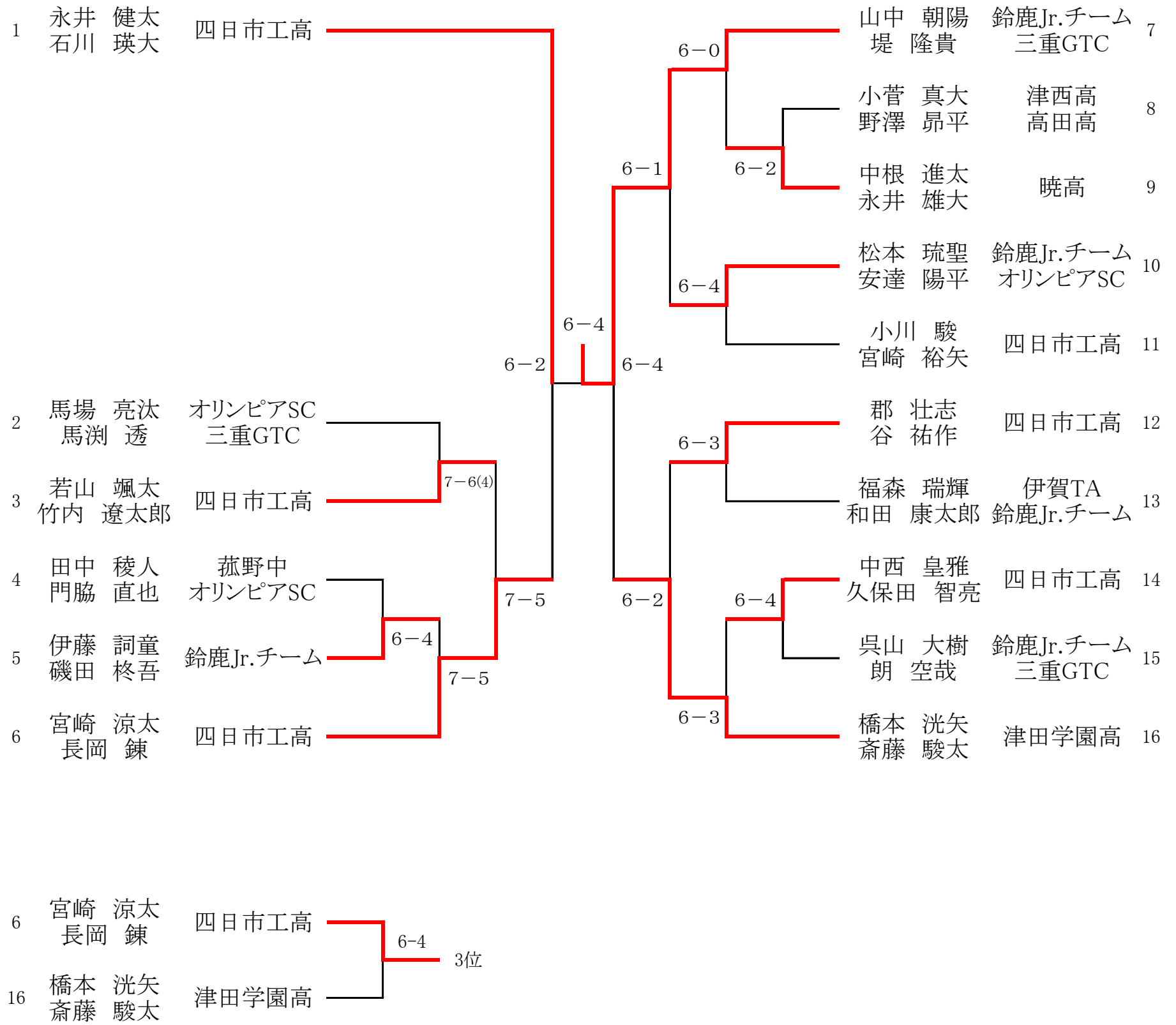

U14MS

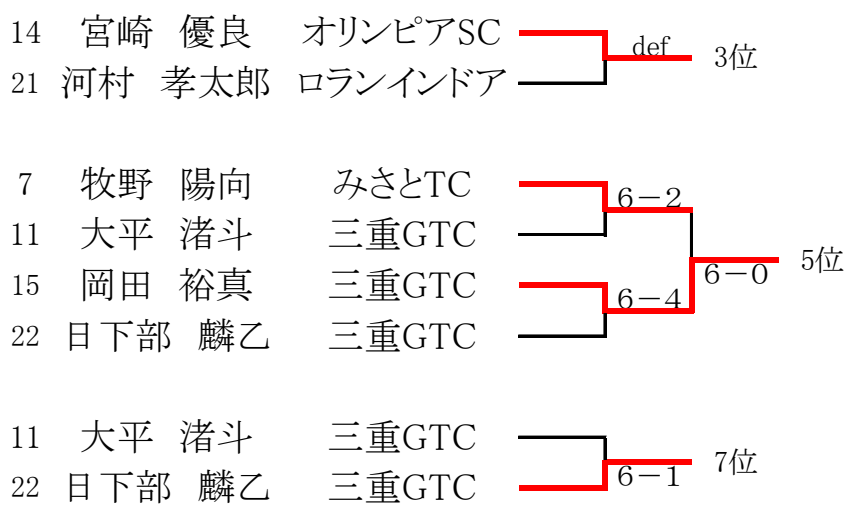
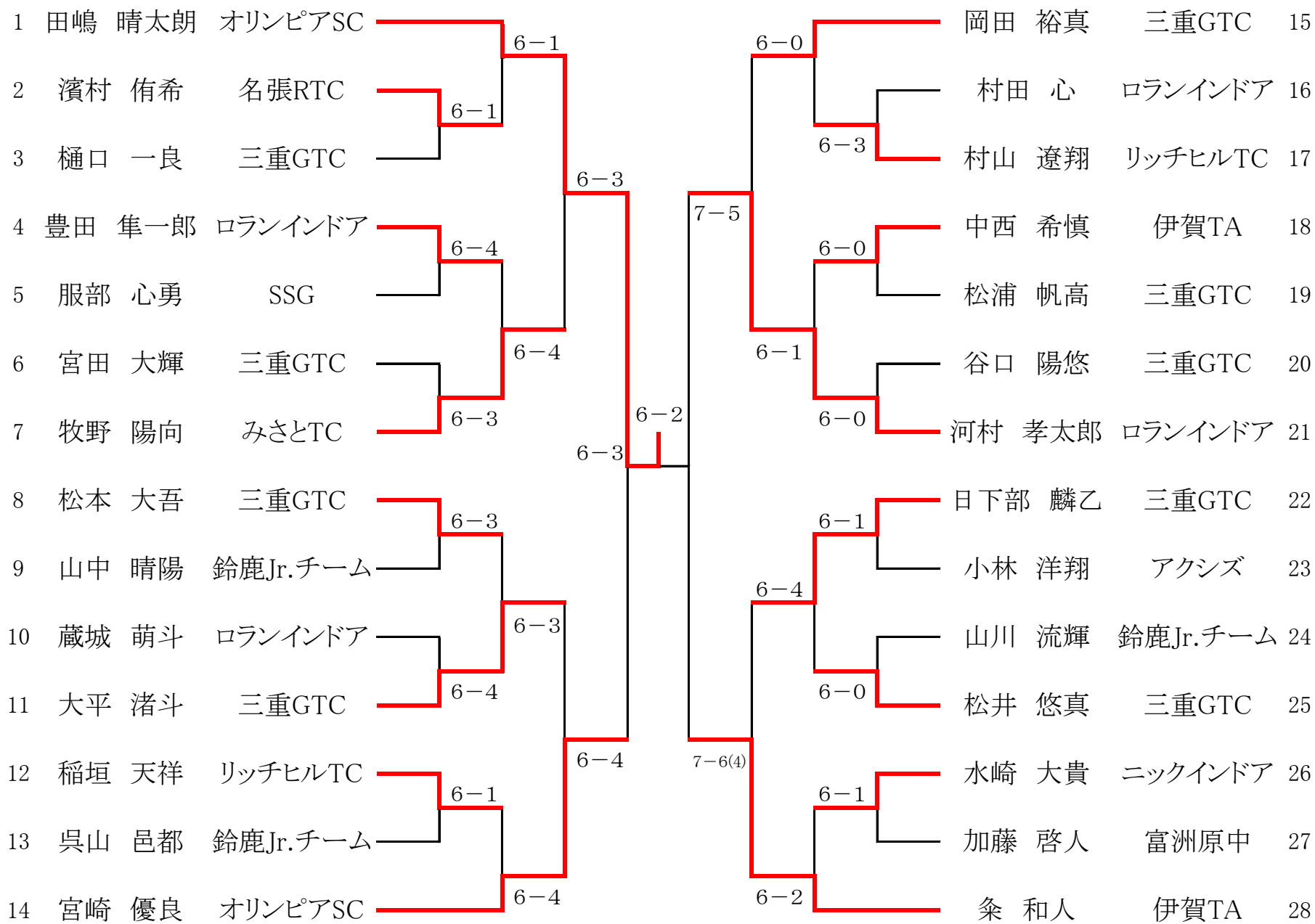

U14MD

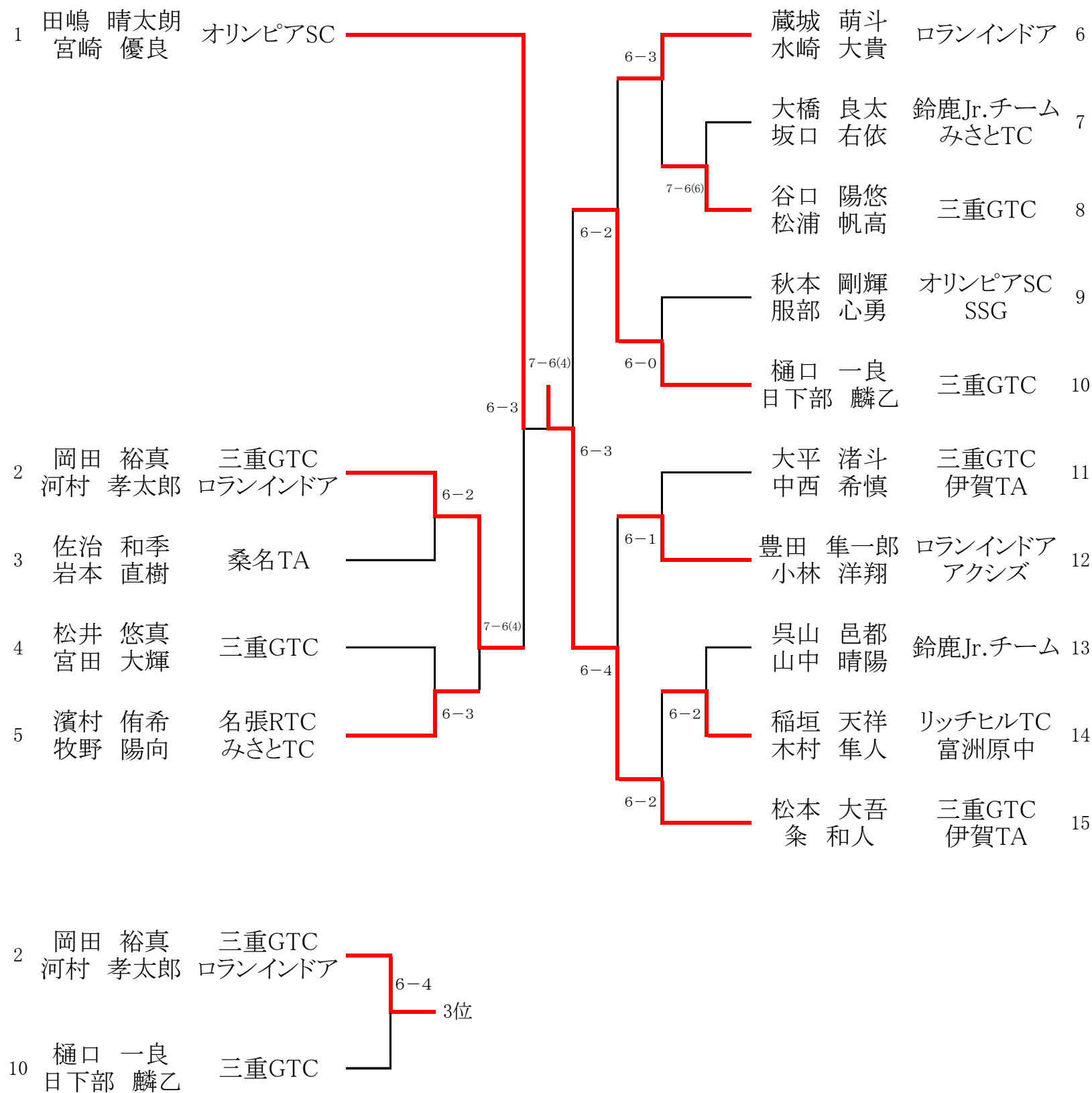

U12MS

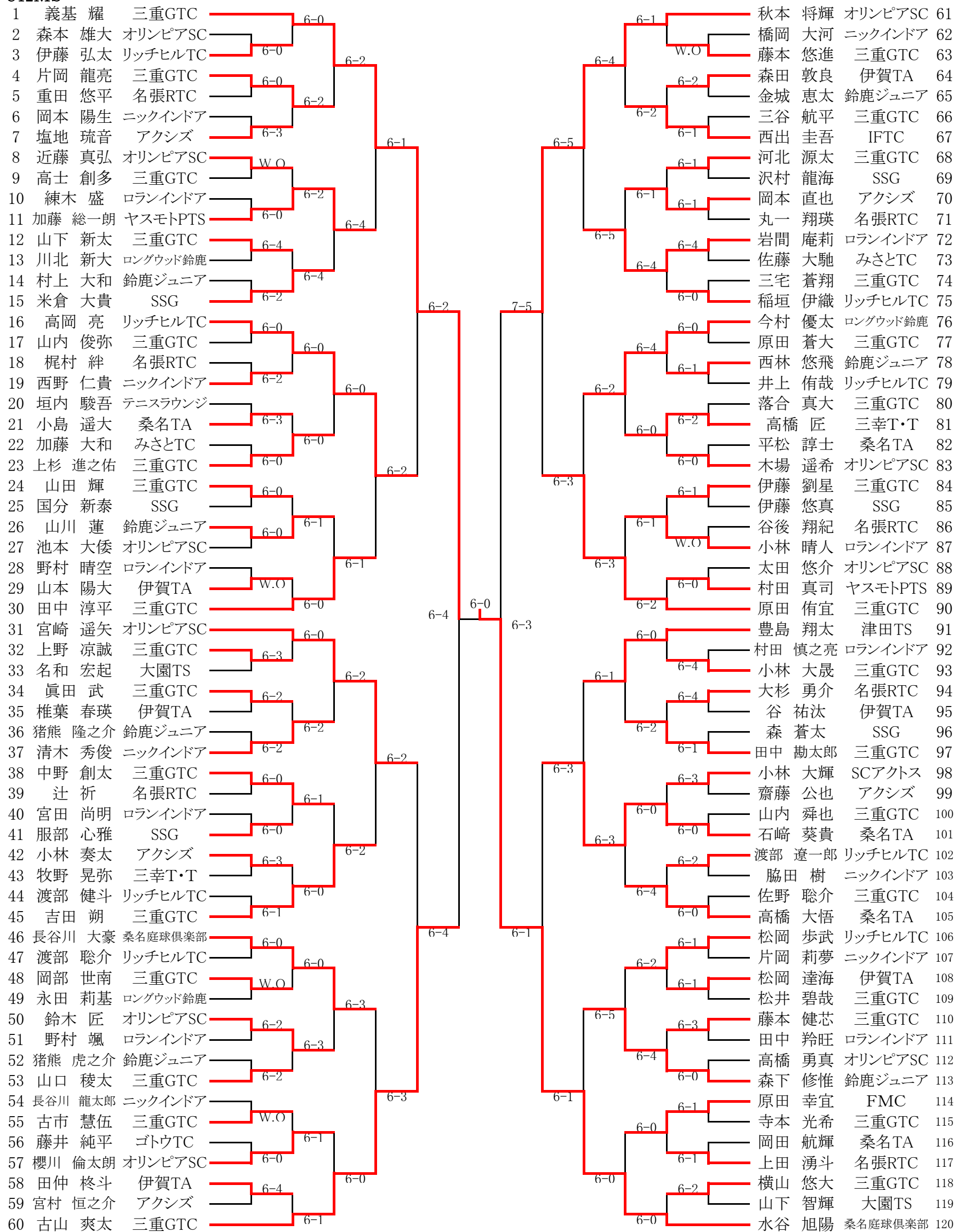

12歳男子順位

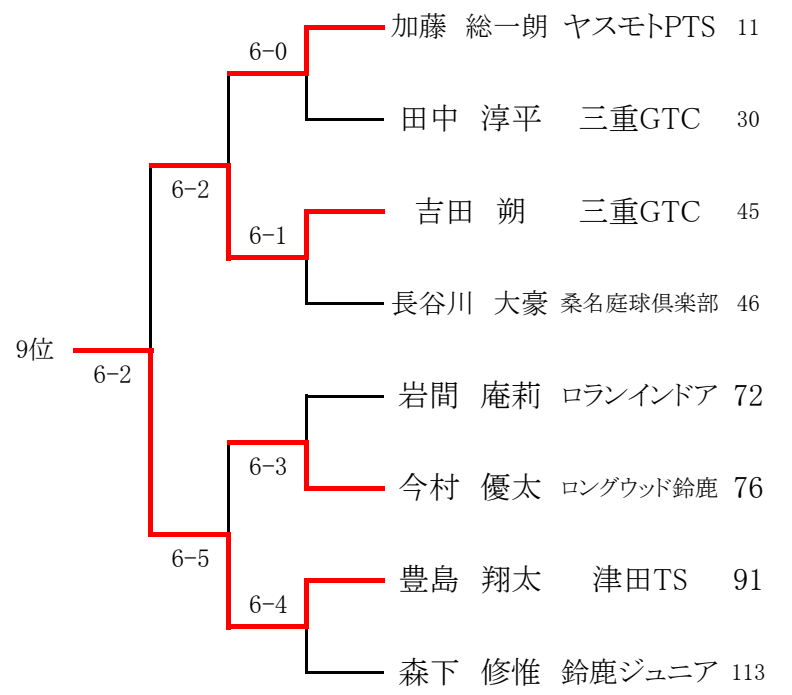
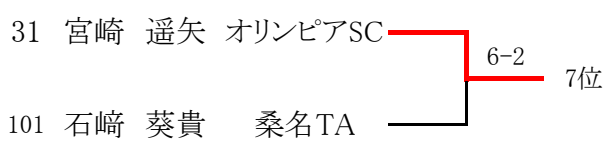
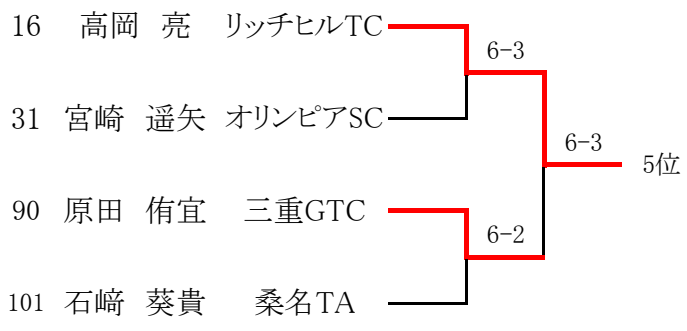

U18WS

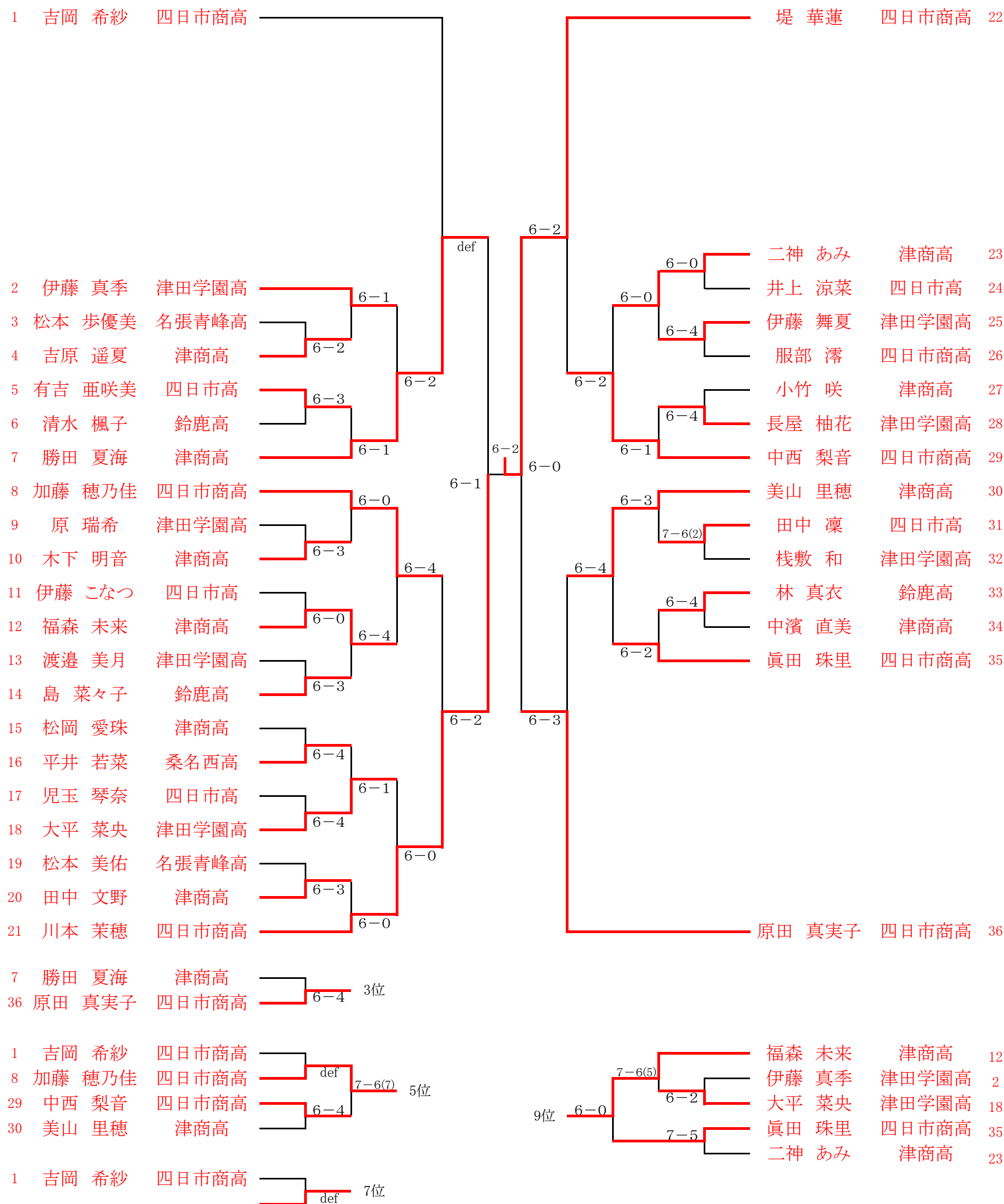

U18WD

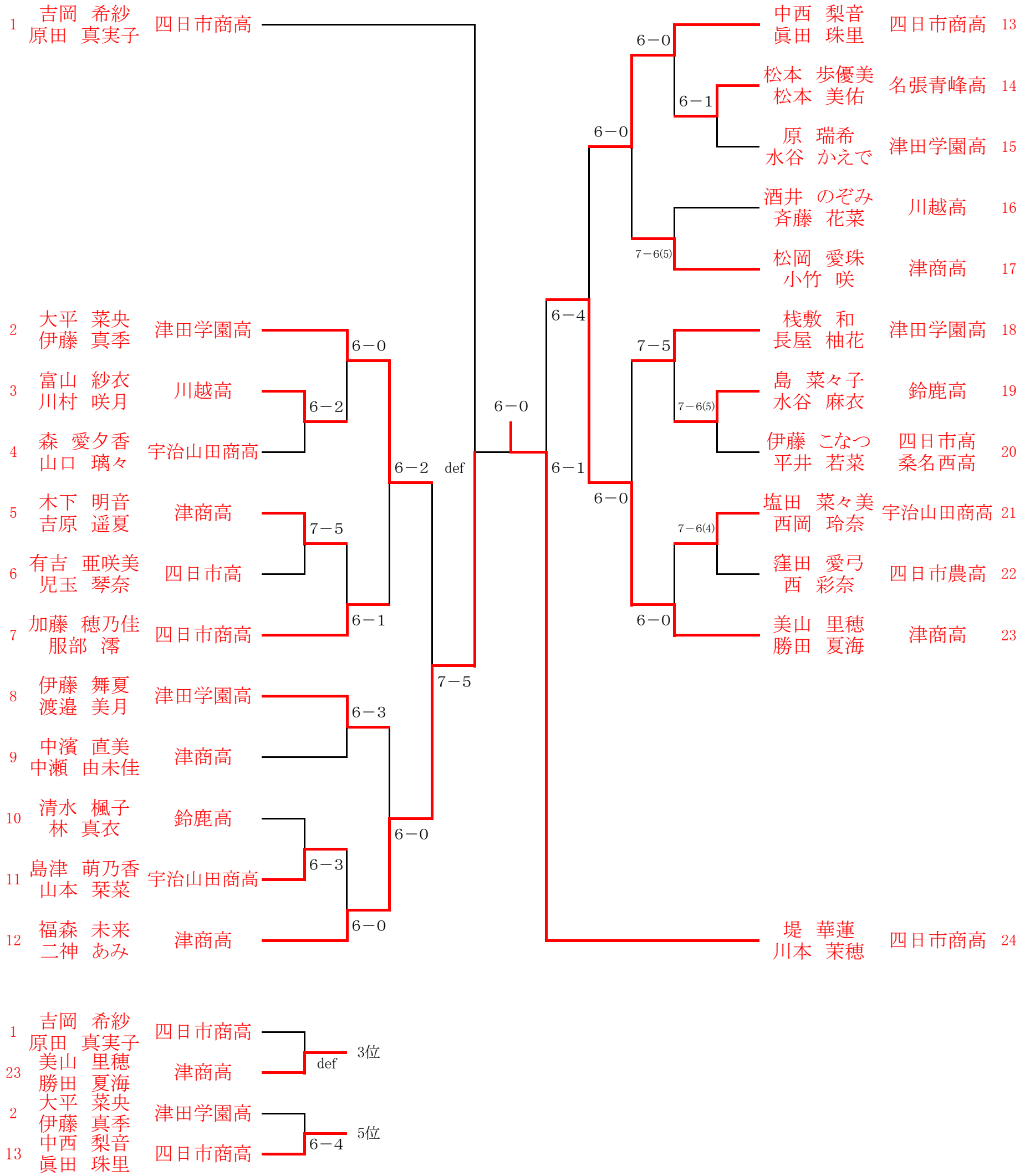

U16WS

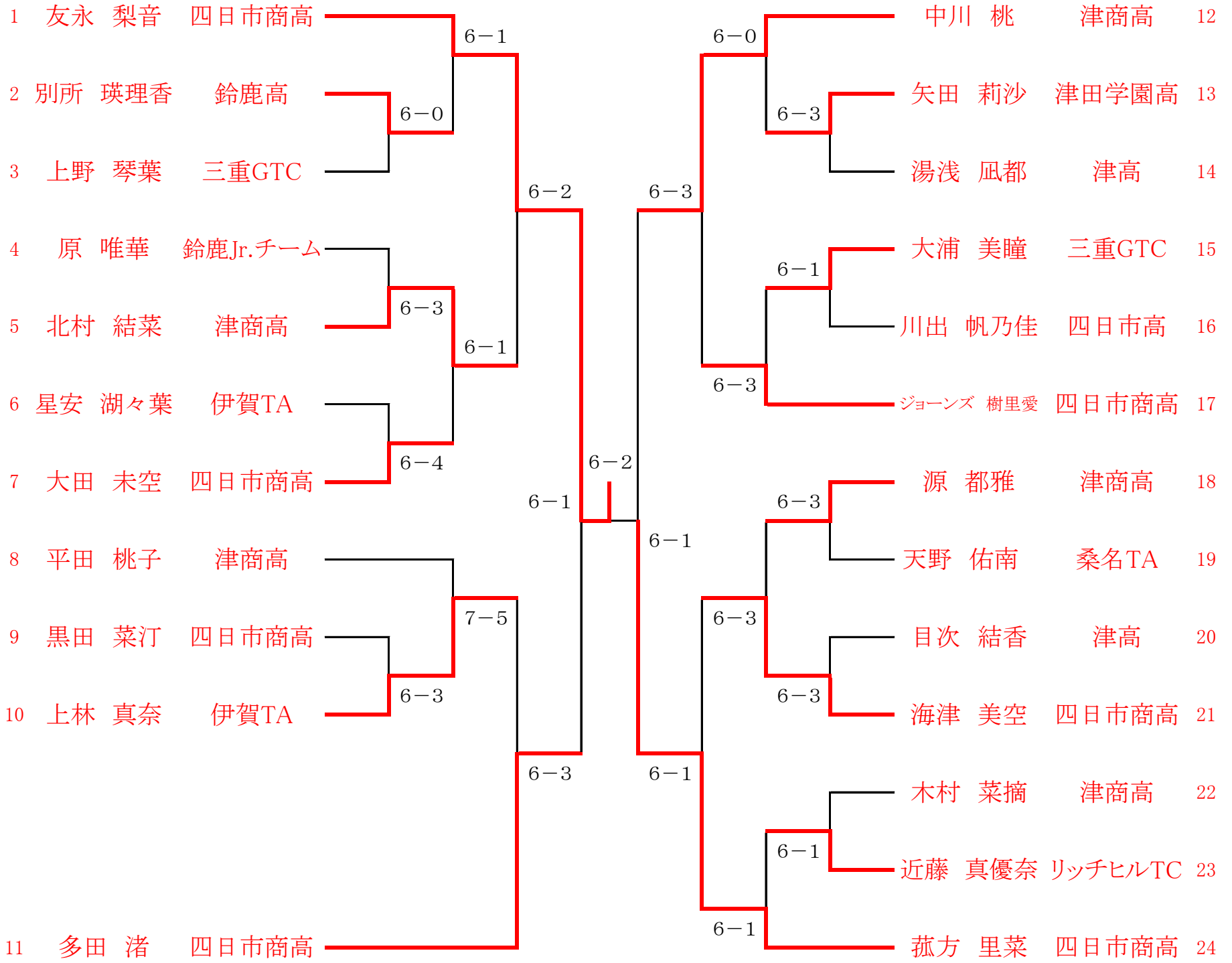

11 多田 渚 四日市商高
12 中川 桃 津商高 3位

5 北村 結菜 津商高
10 上林 真奈 伊賀TA
17 ジョーンズ 樹里愛 四日市商高
21 海津 美空 四日市商高 5位

5 北村 結菜 津商高
21 海津 美空 四日市商高 7位

U16WD

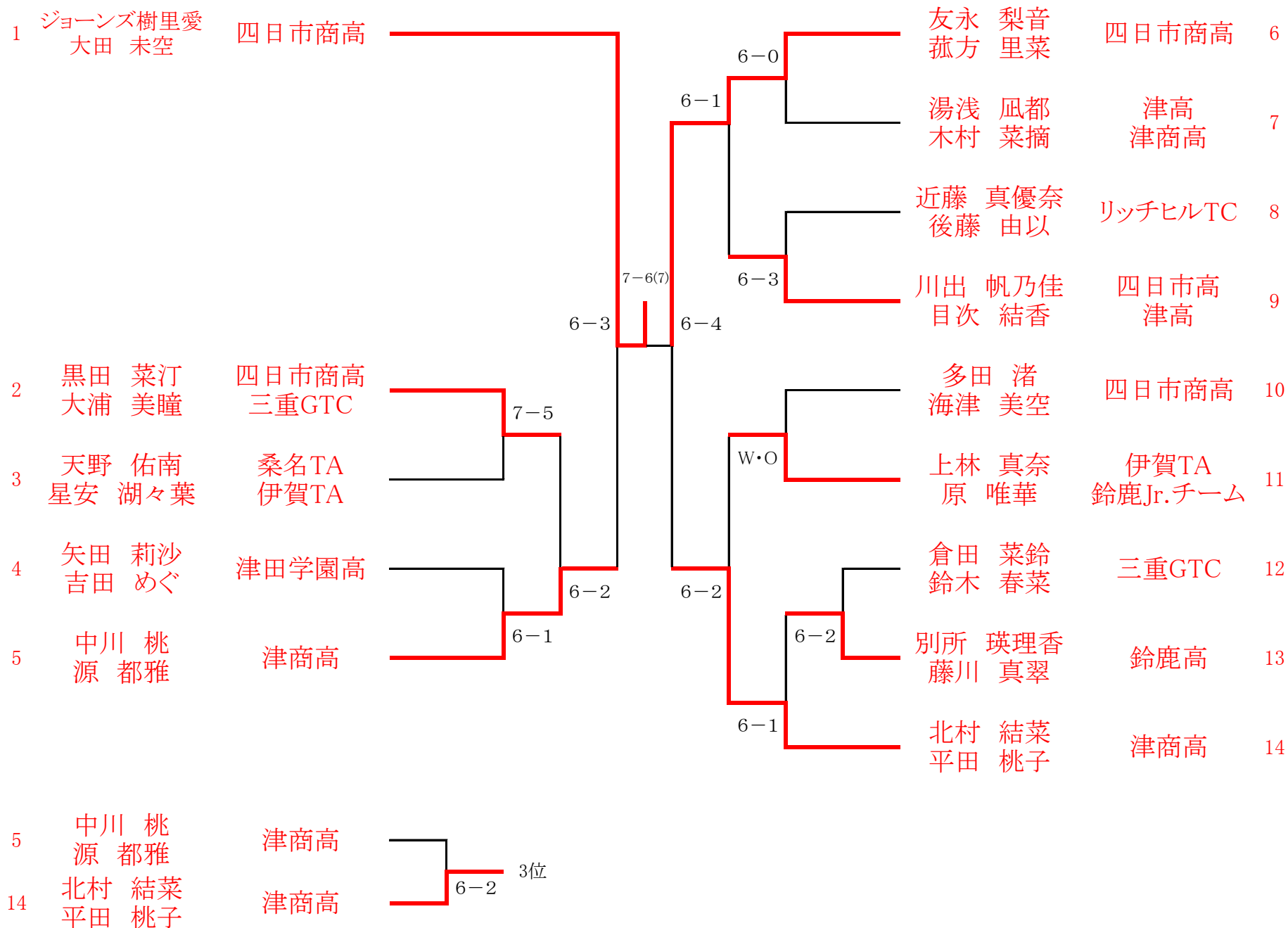

U14WS

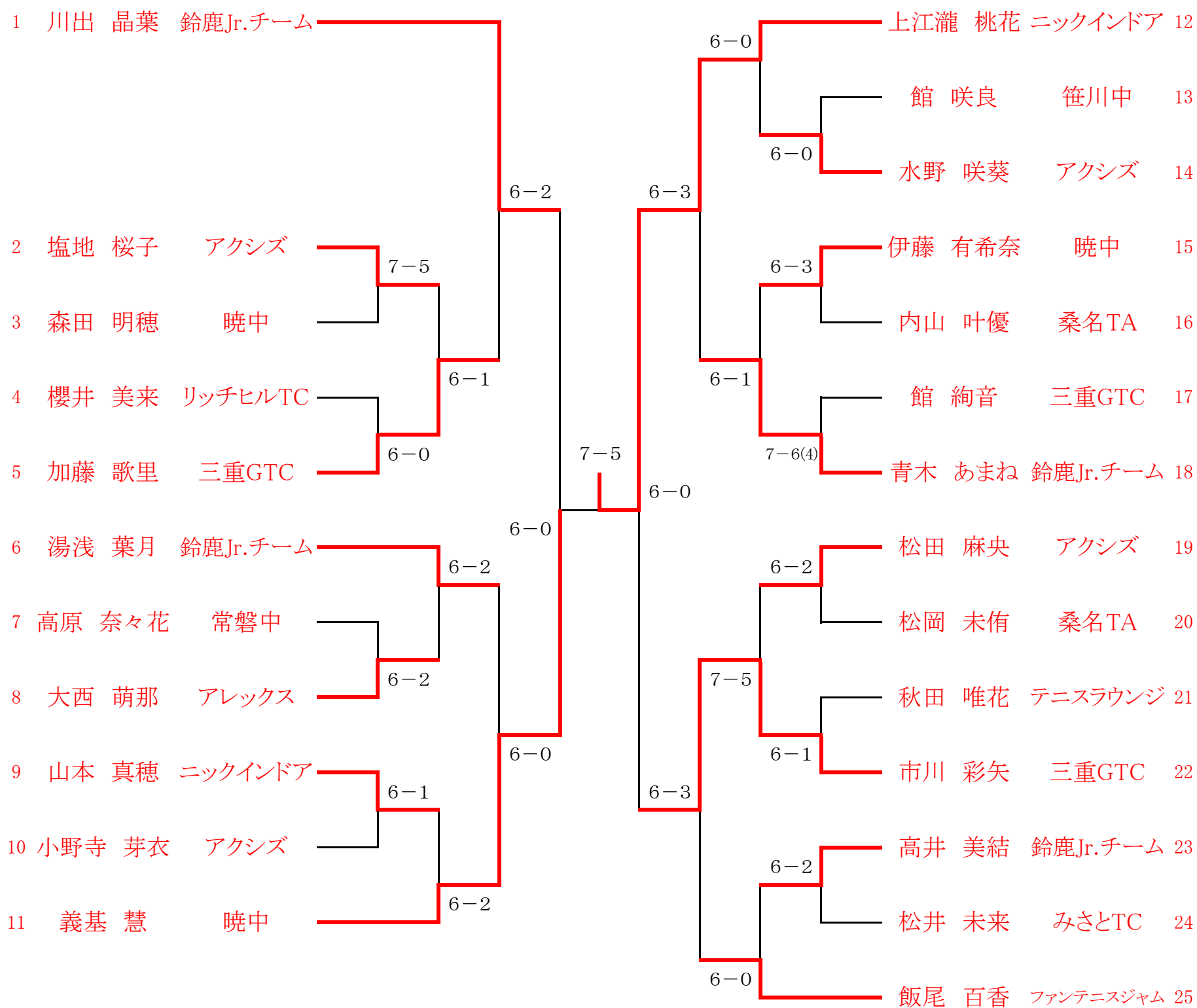

1 川出 晶葉 鈴鹿Jr.チーム 6-3 3位
 22 市川 彩矢 三重GTC

5 加藤 歌里 三重GTC
 6 湯浅 葉月 鈴鹿Jr.チーム 6-1
 18 青木 あまね 鈴鹿Jr.チーム 7-6(3) 5位
 25 飯尾 百香 ファンテニスジャム 6-4

5 加藤 歌里 三重GTC 7-6(4) 7位
 18 青木 あまね 鈴鹿Jr.チーム

U14WD

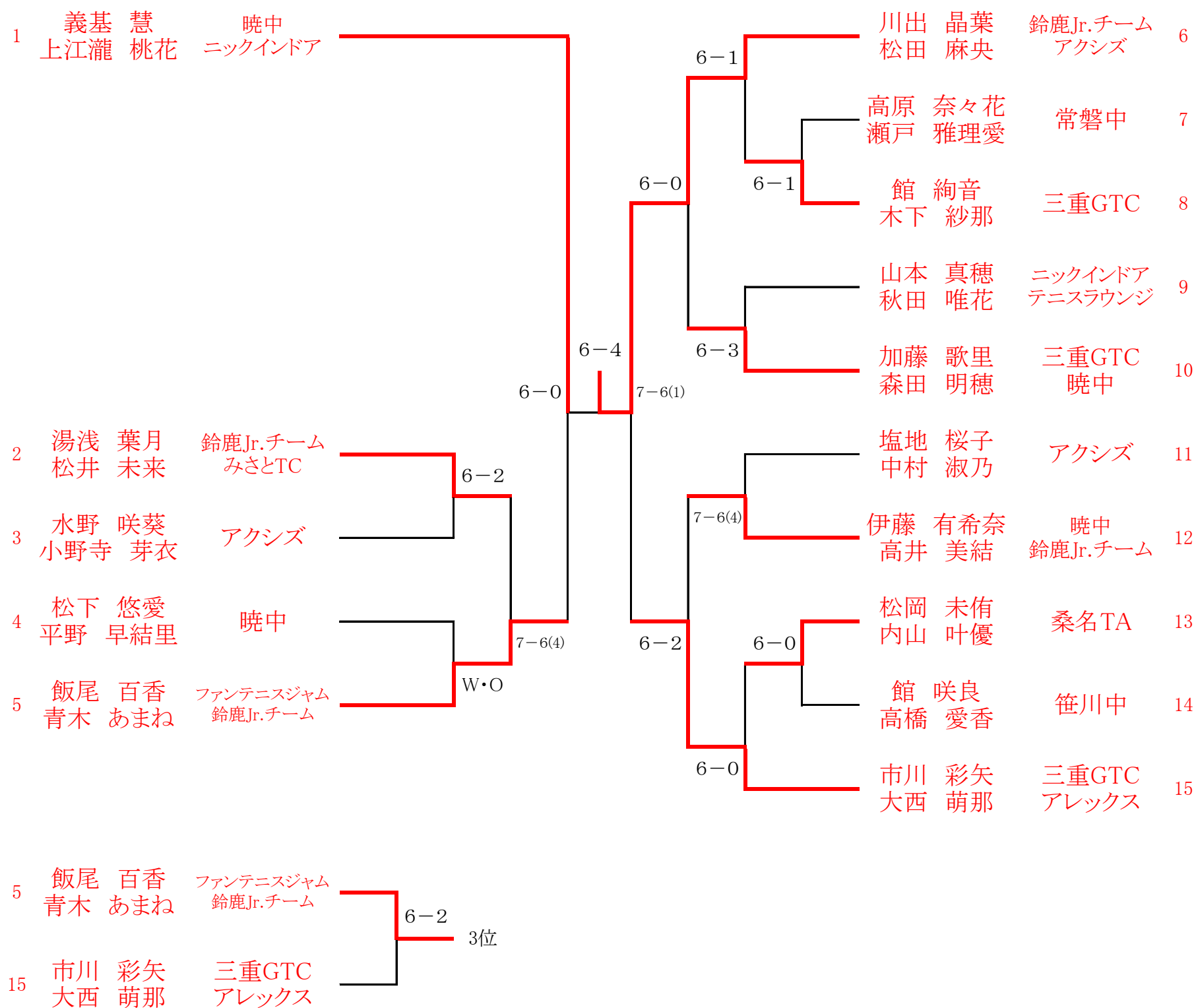

U12WS

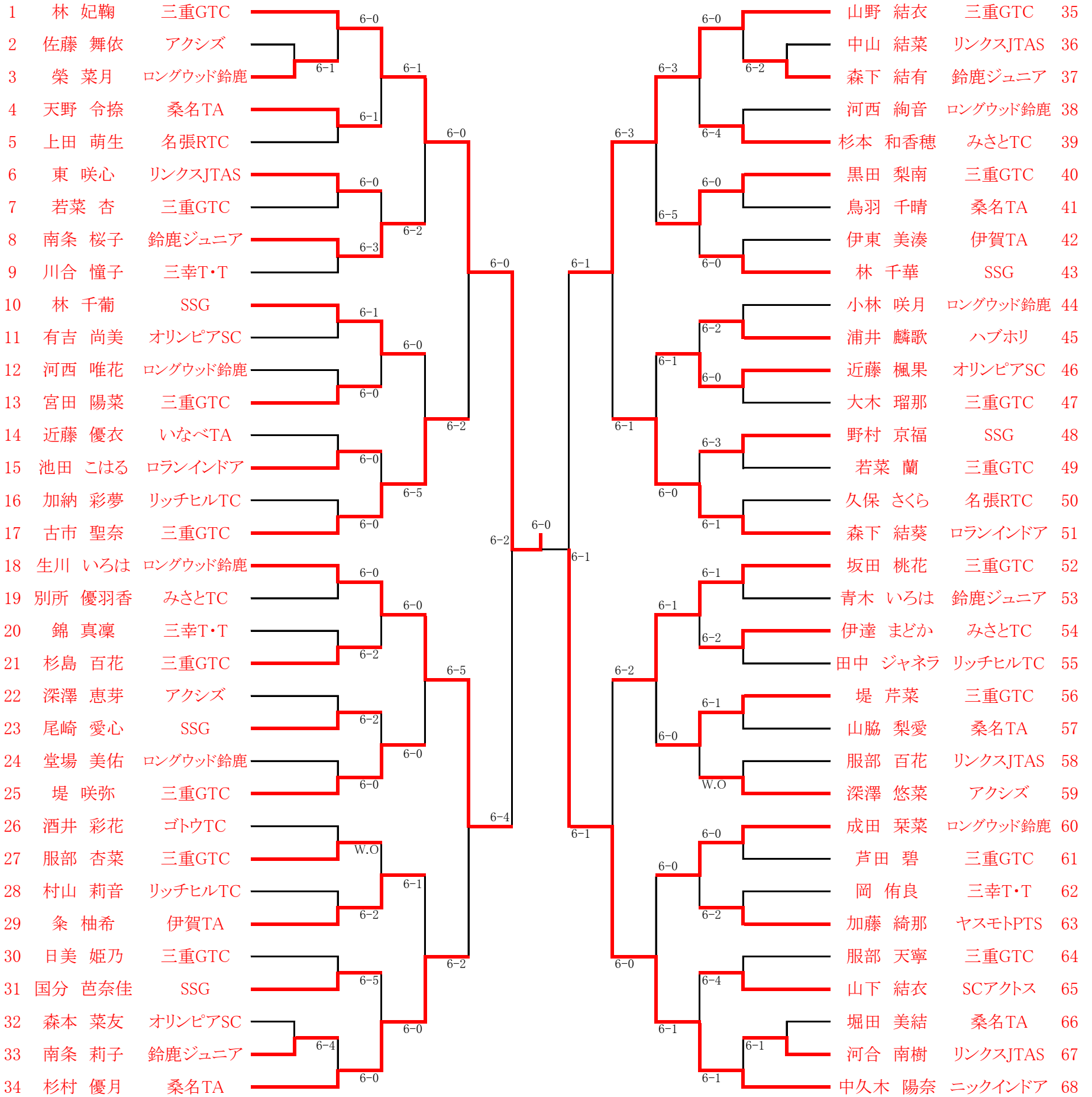

12歳女子順位

